

hobbybricks



McLaren

MCLAREN MP4/4

LEGO TRANSKIT



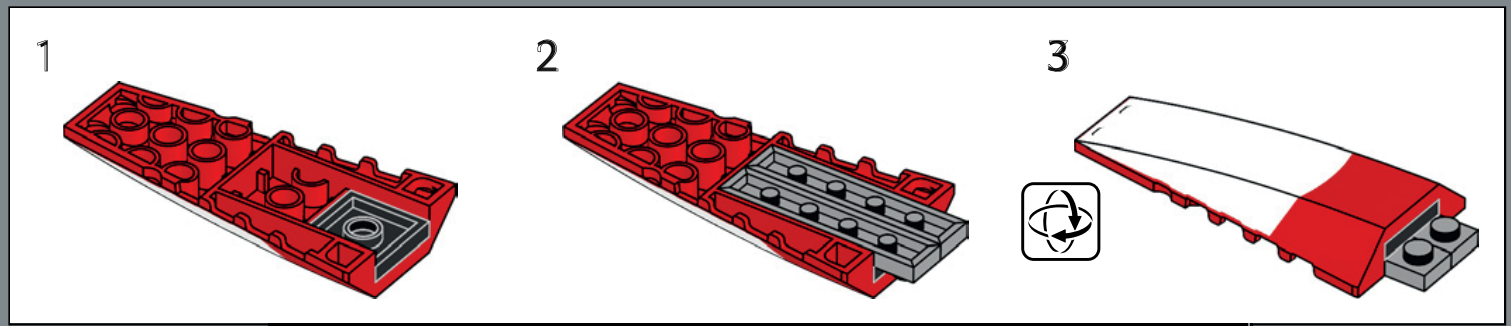
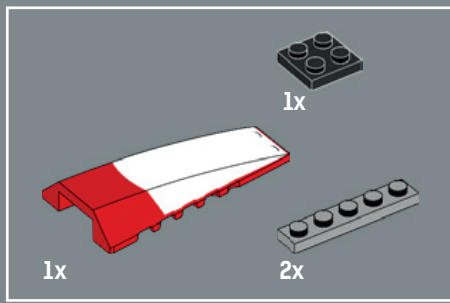

1 Levantar esta pieza para tener acceso a las piezas inferiores..
Lift this part to gain access to the lower parts..

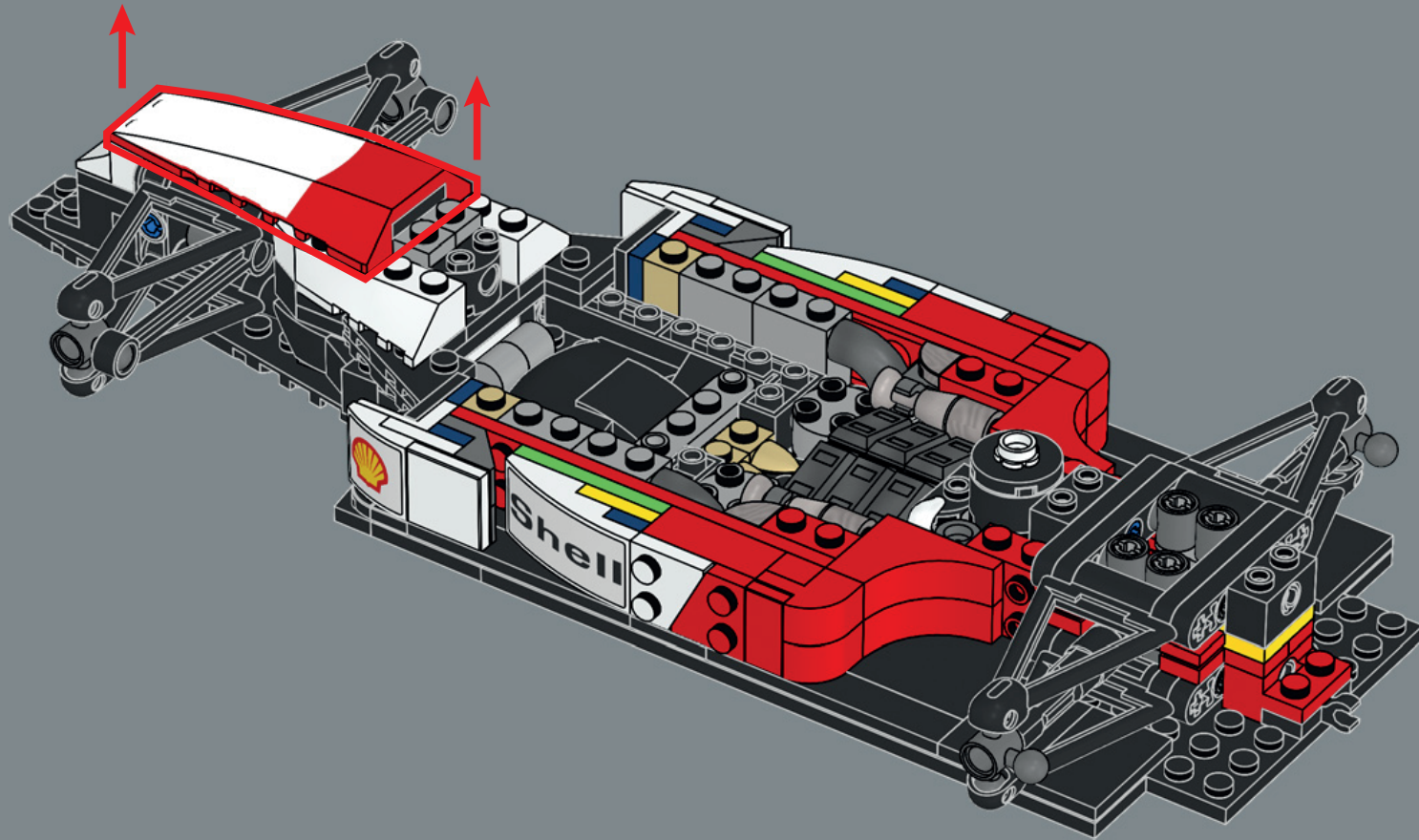

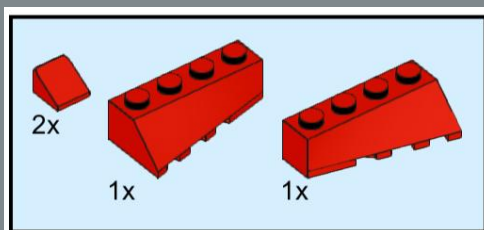
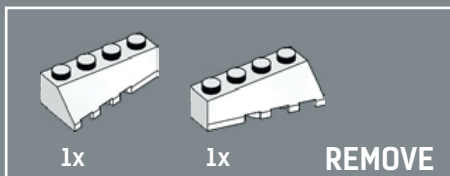

- 2** Extraer las 4 piezas blancas marcadas y sustituirlas por las mismas en color rojo.
Remove the 4 marked white pieces and replace them with the same ones in red.

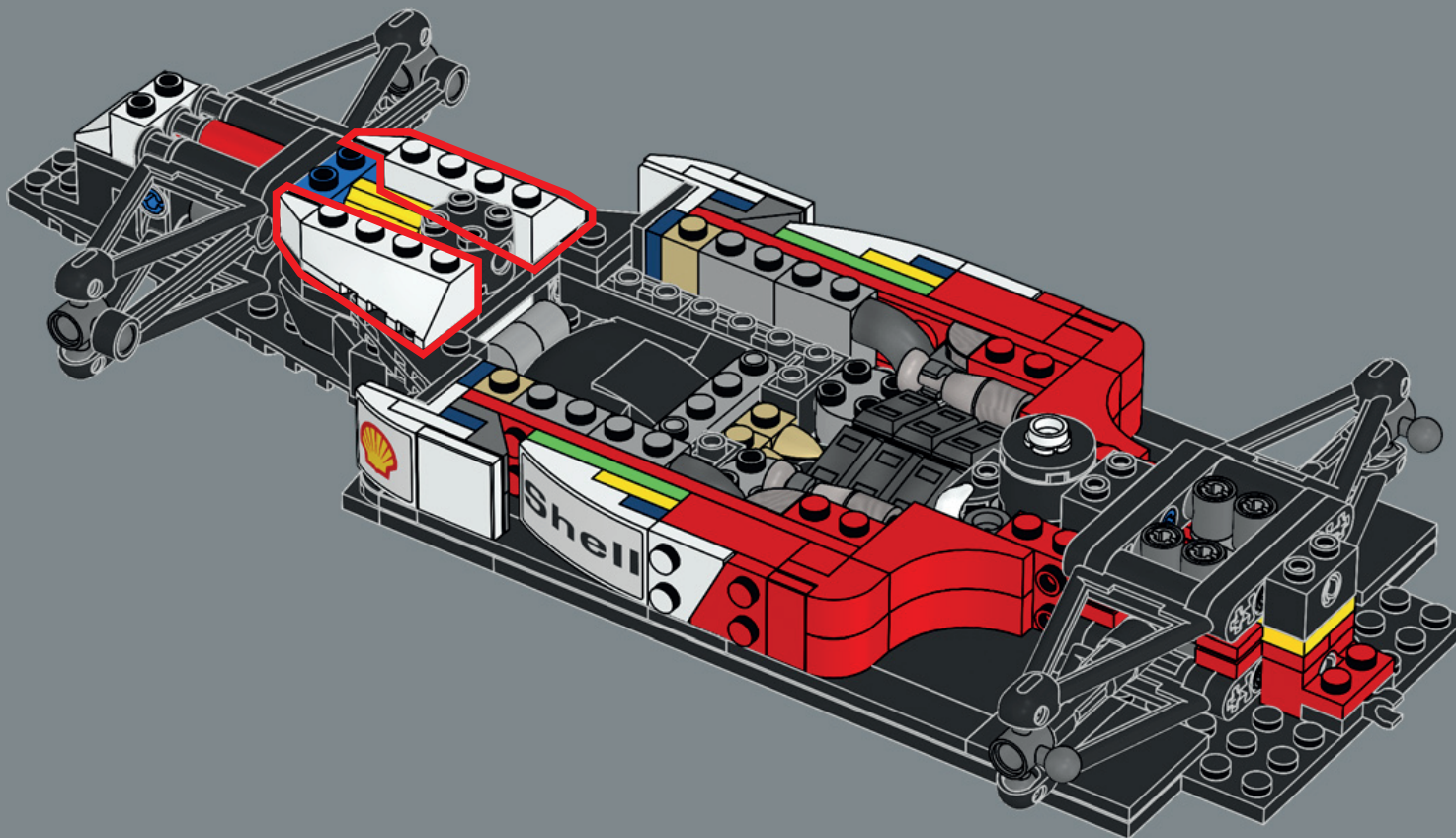

REMOVE



4x



4x

3 Extraer los 4 toques de las ruedas y las ruedas.
Remove the 4 wheel stops and the wheels.

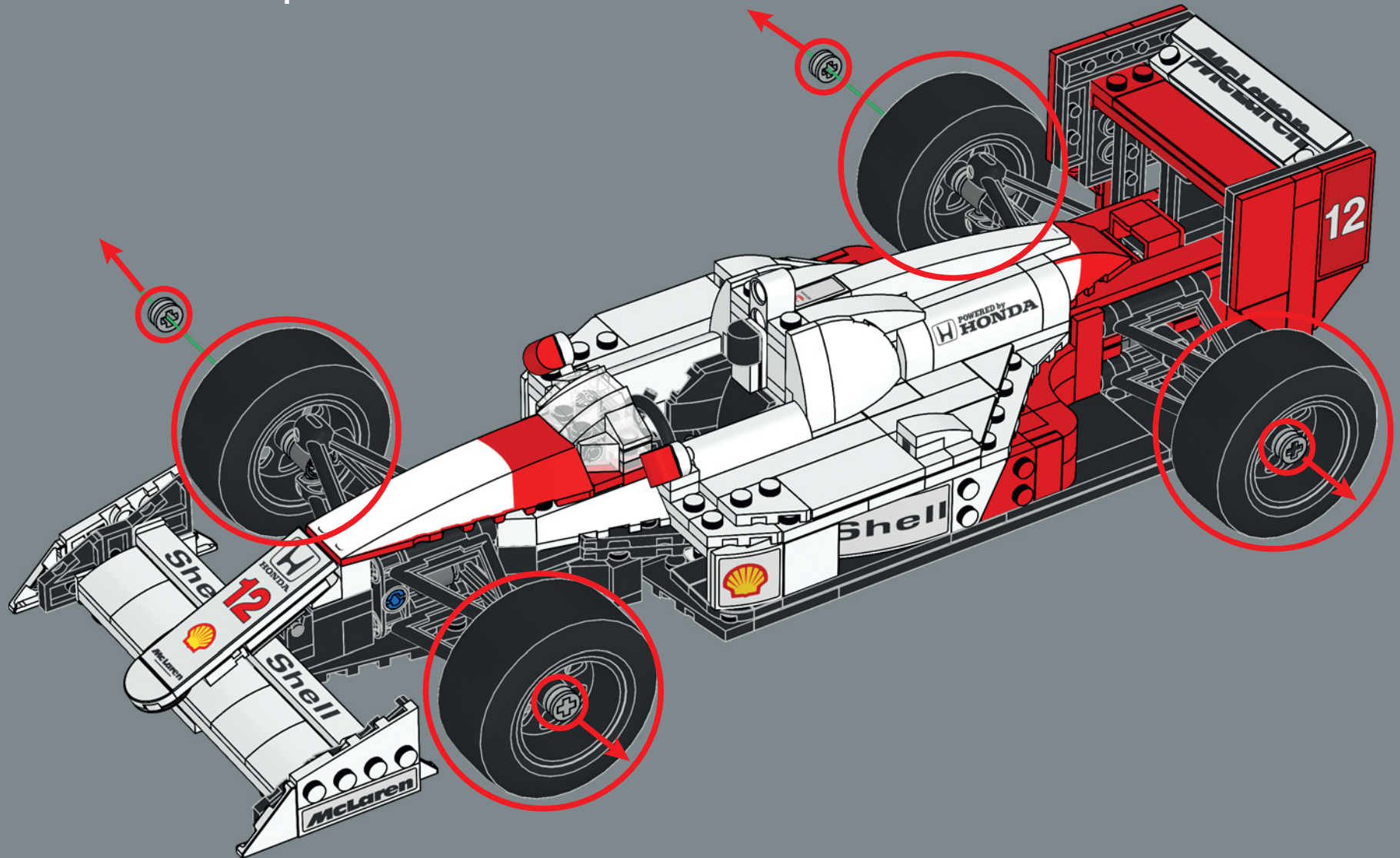

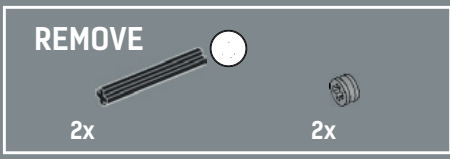

4 Extraer las 4 piezas marcadas y sustituirlas por las del cuadrado azul.
Take out the 4 marked pieces and replace them with the ones in the blue square.

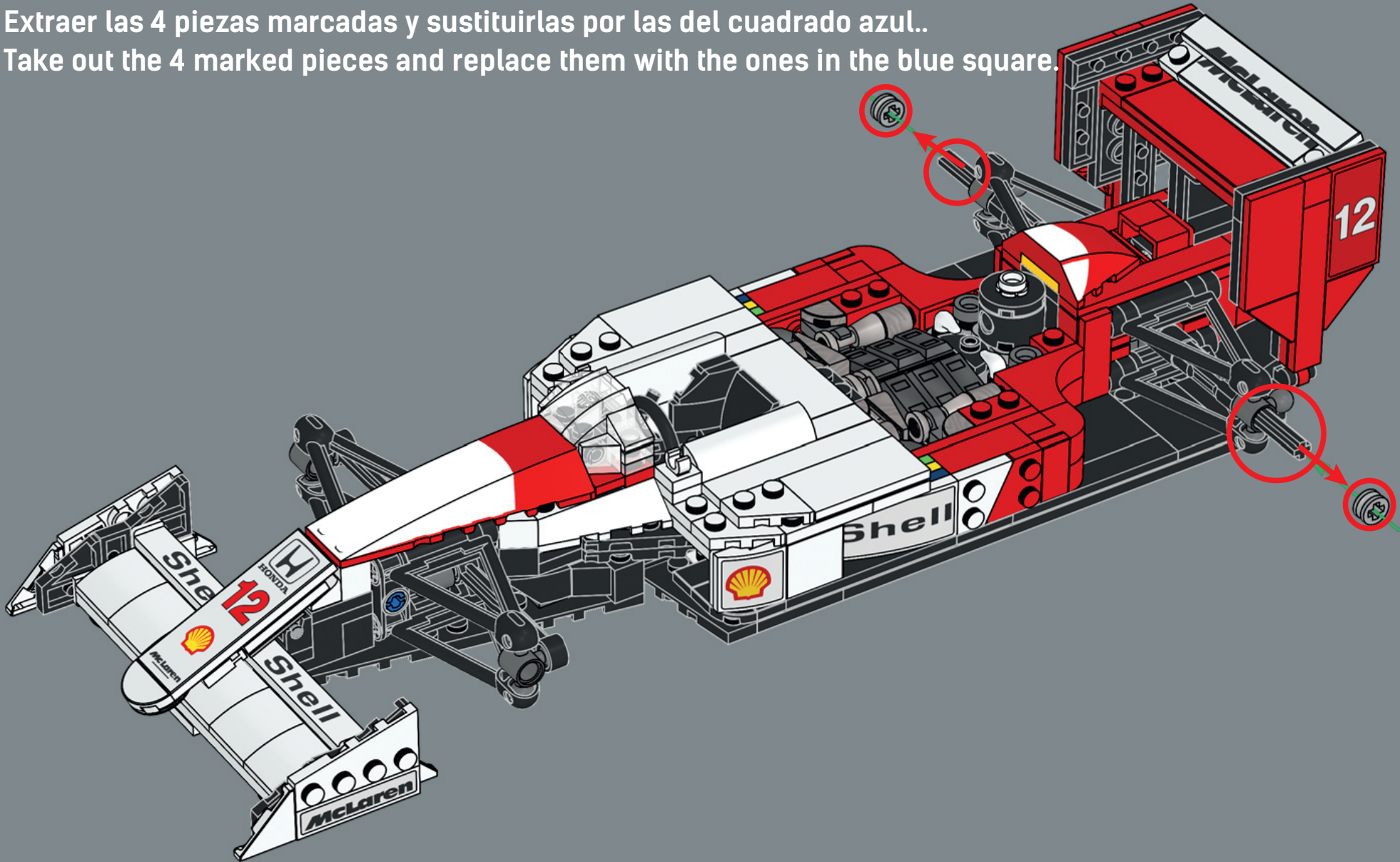

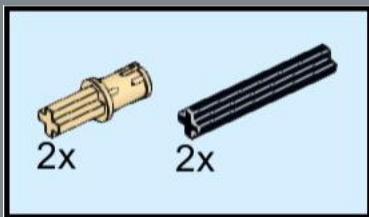

5 Insertar los 4 nuevos conectores.
Insert the 4 new connectors.

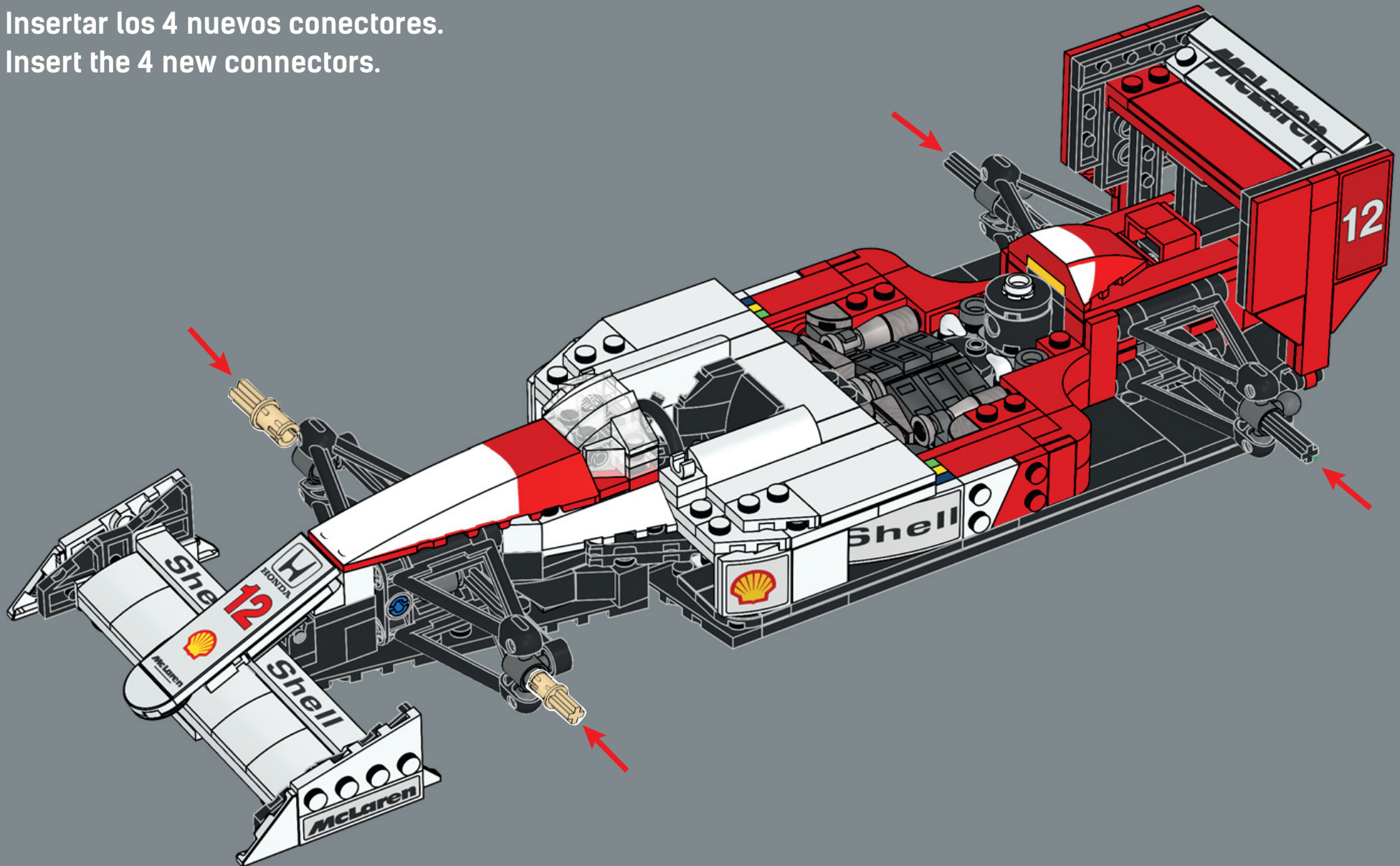

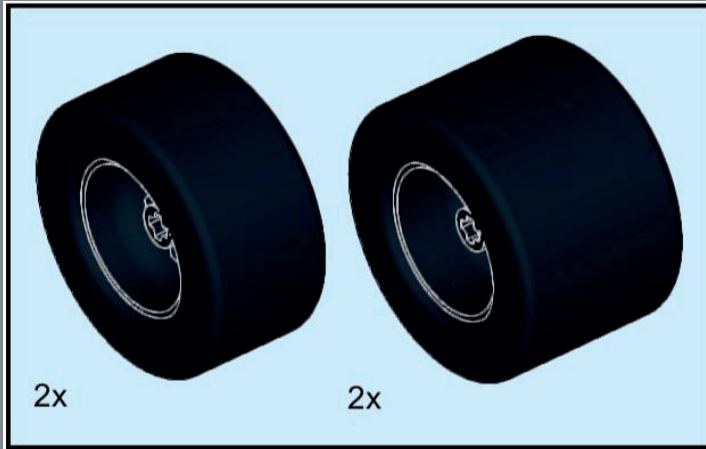

6 Insertar los nuevos neumáticos..
Insert the new tyres.

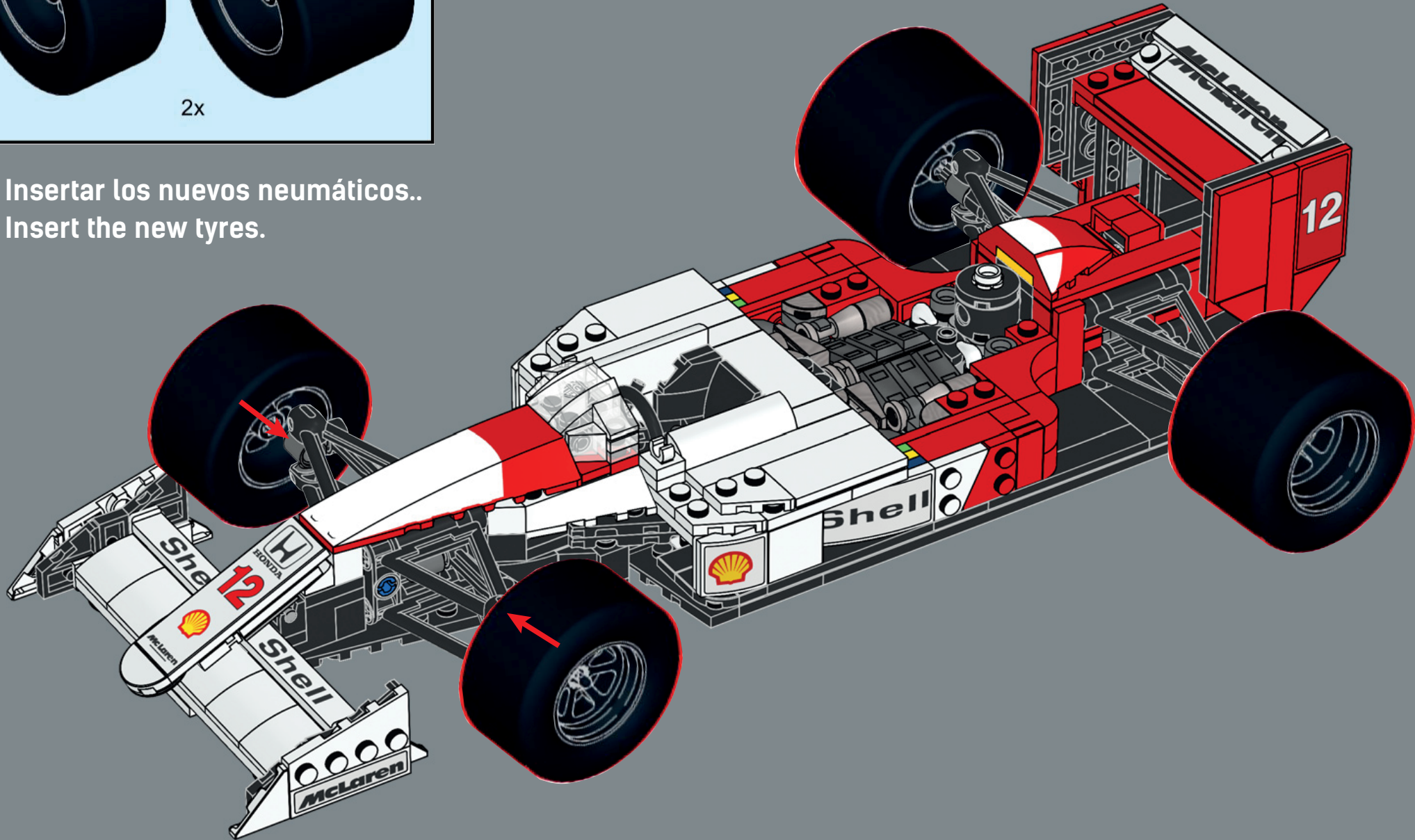

STICKER GUIDE – MP4/4 TRANSKIT

Consejos de colocación en la siguiente página
Placement tips on the following page

hp MP4/4
McLaren MP4/4 Transkit – 10330 LEGO Set
hobbybricks

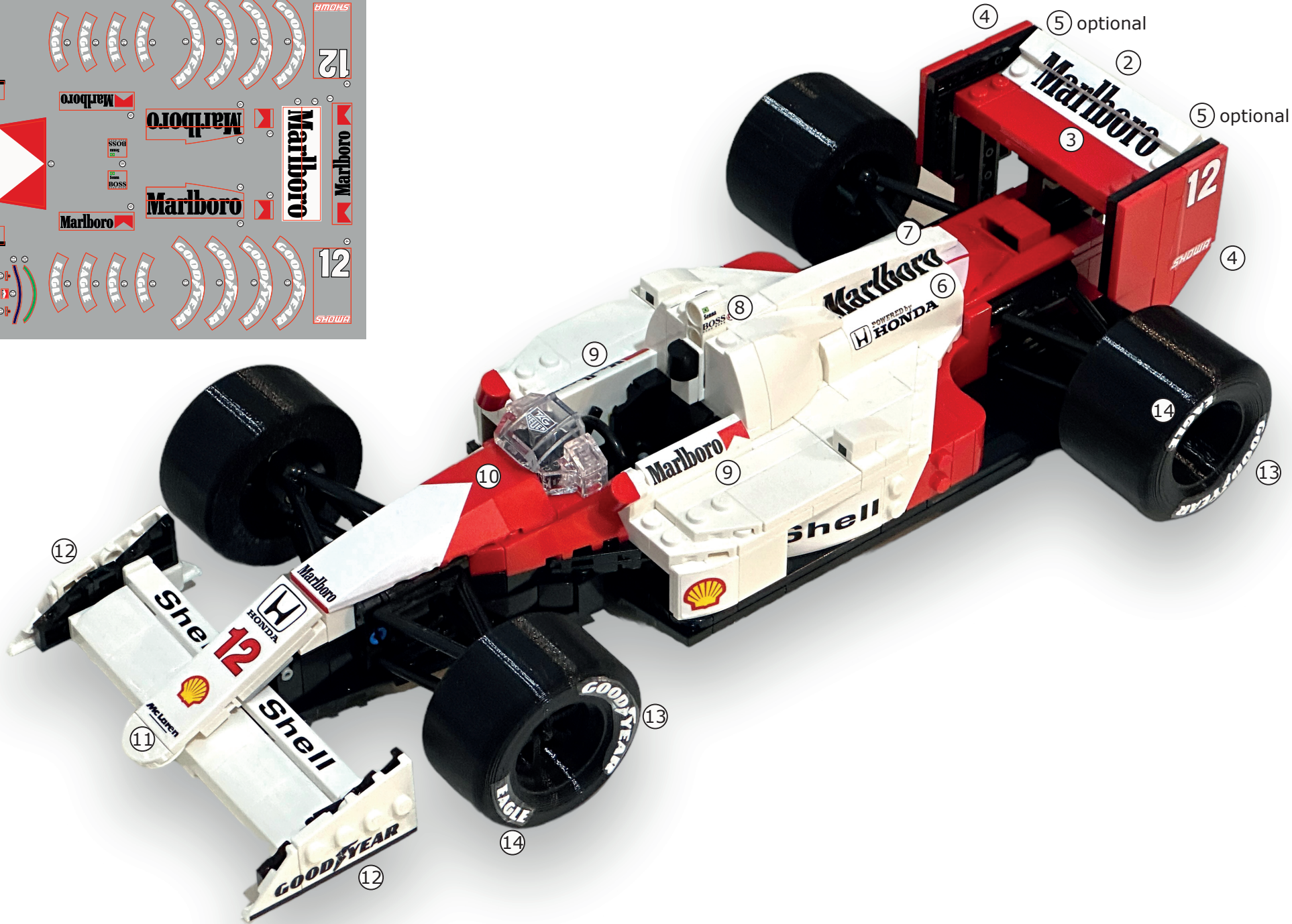
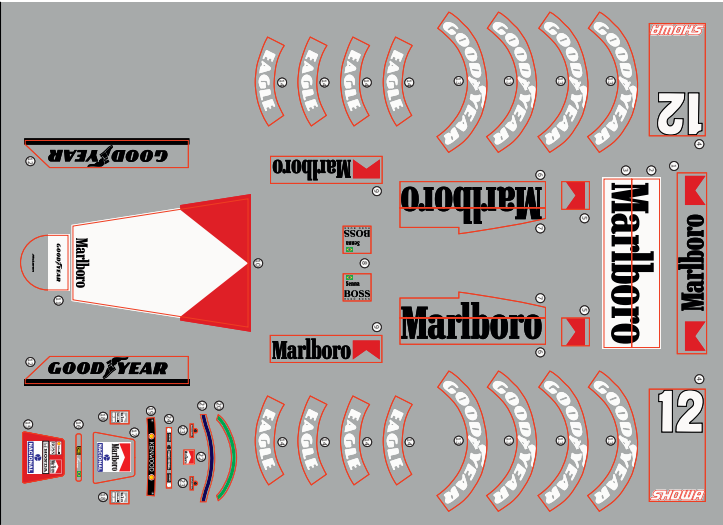

Application tips:

- Use fine-tipped tweezers to separate the Stickers.
- Use hot air gun or hair dryer to apply to Stickers that bend or have to adapt to a curve.
- In case of bubbles use hot air.
- Some Stickers require separating pieces for a better fit.

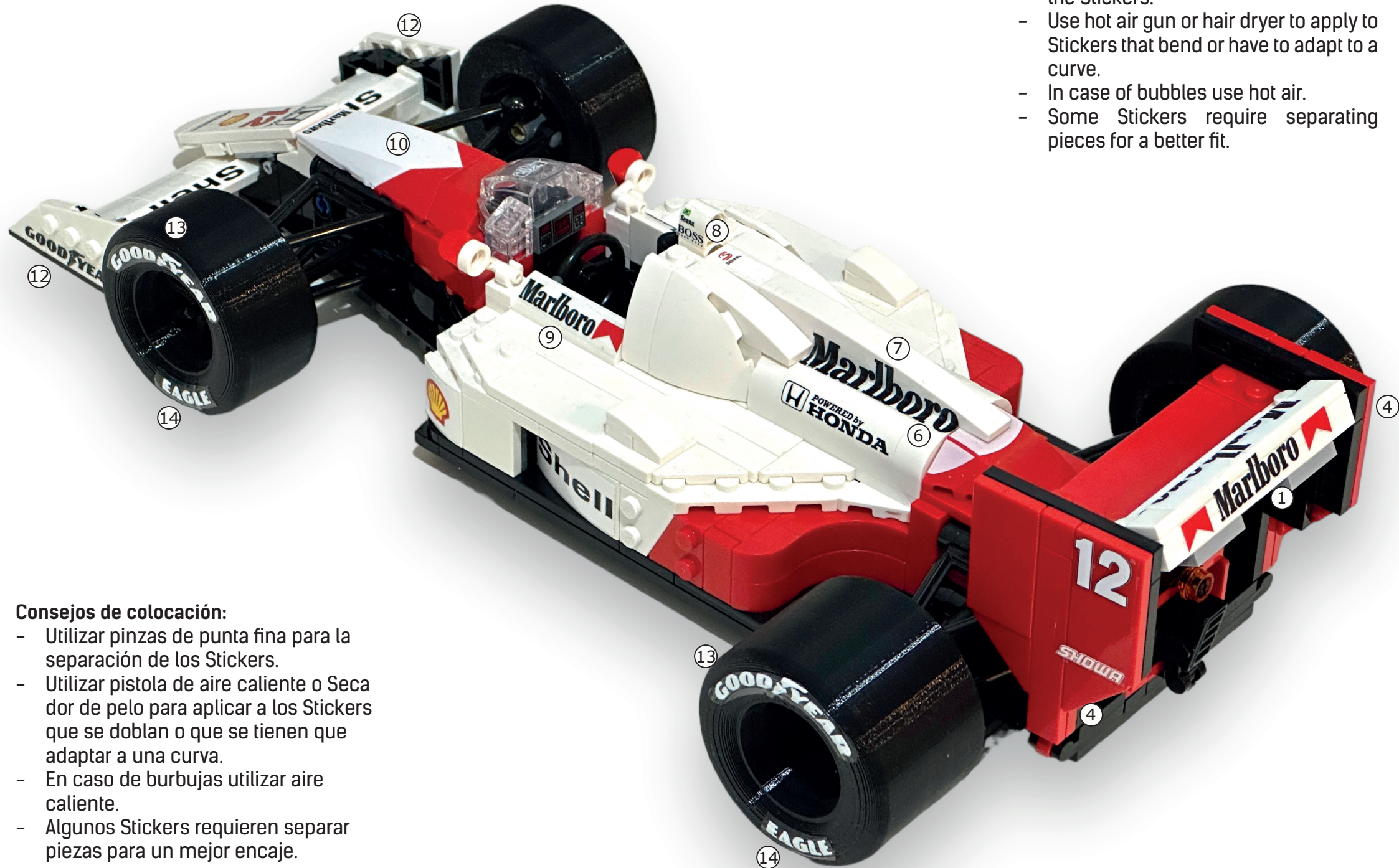

Consejos de colocación:

- Utilizar pinzas de punta fina para la separación de los Stickers.
- Utilizar pistola de aire caliente o Secador de pelo para aplicar a los Stickers que se doblan o que se tienen que adaptar a una curva.
- En caso de burbujas utilizar aire caliente.
- Algunos Stickers requieren separar piezas para un mejor encaje.